

Page Thumbnails

READ MANUAL ON
OPERATION, MAINTENANCE,
REPAIRS, SAFETY AND
WARNING INFORMATION.
SEE THE MANUAL FOR
OPERATING INSTRUCTIONS.

MODEL
SIMON EAGLE
4124
ELECTRIC

PART NO. 89-412707

SIMON

SERVICE MANUAL

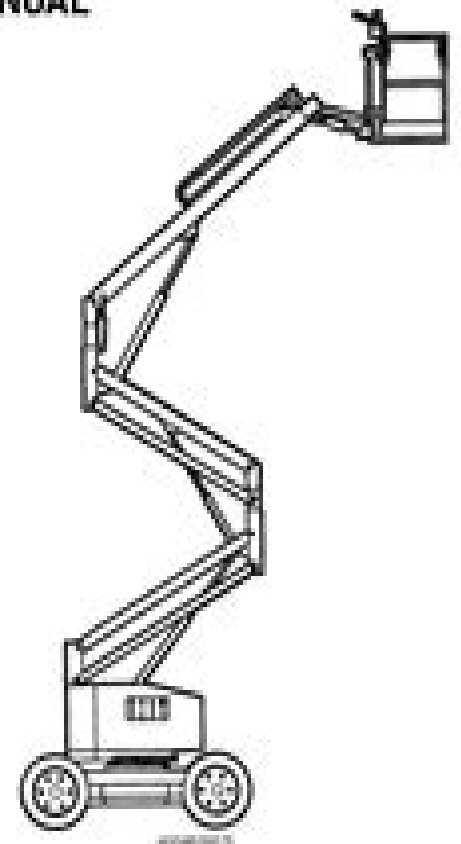

89-412707

Simon Eagle 3221e Technical Service Manual

Jianjun Gao



Simon Eagle 3221e Technical Service Manual:

Simon Eagle 3221e Technical Service Manual Book Review: Unveiling the Power of Words

In a global driven by information and connectivity, the energy of words has be evident than ever. They have the capacity to inspire, provoke, and ignite change. Such could be the essence of the book **Simon Eagle 3221e Technical Service Manual**, a literary masterpiece that delves deep in to the significance of words and their effect on our lives. Written by a renowned author, this captivating work takes readers on a transformative journey, unraveling the secrets and potential behind every word. In this review, we shall explore the book is key themes, examine its writing style, and analyze its overall impact on readers.

https://movement.livewellcolorado.org/files/virtual-library/Download_PDFS/the%20book%20of%20meditation%20the%20complete%20guide%20to%20modern%20meditation.pdf

Table of Contents Simon Eagle 3221e Technical Service Manual

1. Understanding the eBook Simon Eagle 3221e Technical Service Manual
 - The Rise of Digital Reading Simon Eagle 3221e Technical Service Manual
 - Advantages of eBooks Over Traditional Books
2. Identifying Simon Eagle 3221e Technical Service Manual
 - Exploring Different Genres
 - Considering Fiction vs. Non-Fiction
 - Determining Your Reading Goals
3. Choosing the Right eBook Platform
 - Popular eBook Platforms
 - Features to Look for in an Simon Eagle 3221e Technical Service Manual
 - User-Friendly Interface
4. Exploring eBook Recommendations from Simon Eagle 3221e Technical Service Manual
 - Personalized Recommendations
 - Simon Eagle 3221e Technical Service Manual User Reviews and Ratings

- Simon Eagle 3221e Technical Service Manual and Bestseller Lists
- 5. Accessing Simon Eagle 3221e Technical Service Manual Free and Paid eBooks
 - Simon Eagle 3221e Technical Service Manual Public Domain eBooks
 - Simon Eagle 3221e Technical Service Manual eBook Subscription Services
 - Simon Eagle 3221e Technical Service Manual Budget-Friendly Options
- 6. Navigating Simon Eagle 3221e Technical Service Manual eBook Formats
 - ePub, PDF, MOBI, and More
 - Simon Eagle 3221e Technical Service Manual Compatibility with Devices
 - Simon Eagle 3221e Technical Service Manual Enhanced eBook Features
- 7. Enhancing Your Reading Experience
 - Adjustable Fonts and Text Sizes of Simon Eagle 3221e Technical Service Manual
 - Highlighting and Note-Taking Simon Eagle 3221e Technical Service Manual
 - Interactive Elements Simon Eagle 3221e Technical Service Manual
- 8. Staying Engaged with Simon Eagle 3221e Technical Service Manual
 - Joining Online Reading Communities
 - Participating in Virtual Book Clubs
 - Following Authors and Publishers Simon Eagle 3221e Technical Service Manual
- 9. Balancing eBooks and Physical Books Simon Eagle 3221e Technical Service Manual
 - Benefits of a Digital Library
 - Creating a Diverse Reading Collection Simon Eagle 3221e Technical Service Manual
- 10. Overcoming Reading Challenges
 - Dealing with Digital Eye Strain
 - Minimizing Distractions
 - Managing Screen Time
- 11. Cultivating a Reading Routine Simon Eagle 3221e Technical Service Manual
 - Setting Reading Goals Simon Eagle 3221e Technical Service Manual
 - Carving Out Dedicated Reading Time
- 12. Sourcing Reliable Information of Simon Eagle 3221e Technical Service Manual
 - Fact-Checking eBook Content of Simon Eagle 3221e Technical Service Manual
 - Distinguishing Credible Sources

13. Promoting Lifelong Learning
 - Utilizing eBooks for Skill Development
 - Exploring Educational eBooks
14. Embracing eBook Trends
 - Integration of Multimedia Elements
 - Interactive and Gamified eBooks

Simon Eagle 3221e Technical Service Manual Introduction

Free PDF Books and Manuals for Download: Unlocking Knowledge at Your Fingertips In today's fast-paced digital age, obtaining valuable knowledge has become easier than ever. Thanks to the internet, a vast array of books and manuals are now available for free download in PDF format. Whether you are a student, professional, or simply an avid reader, this treasure trove of downloadable resources offers a wealth of information, conveniently accessible anytime, anywhere. The advent of online libraries and platforms dedicated to sharing knowledge has revolutionized the way we consume information. No longer confined to physical libraries or bookstores, readers can now access an extensive collection of digital books and manuals with just a few clicks. These resources, available in PDF, Microsoft Word, and PowerPoint formats, cater to a wide range of interests, including literature, technology, science, history, and much more. One notable platform where you can explore and download free Simon Eagle 3221e Technical Service Manual PDF books and manuals is the internet's largest free library. Hosted online, this catalog compiles a vast assortment of documents, making it a veritable goldmine of knowledge. With its easy-to-use website interface and customizable PDF generator, this platform offers a user-friendly experience, allowing individuals to effortlessly navigate and access the information they seek. The availability of free PDF books and manuals on this platform demonstrates its commitment to democratizing education and empowering individuals with the tools needed to succeed in their chosen fields. It allows anyone, regardless of their background or financial limitations, to expand their horizons and gain insights from experts in various disciplines. One of the most significant advantages of downloading PDF books and manuals lies in their portability. Unlike physical copies, digital books can be stored and carried on a single device, such as a tablet or smartphone, saving valuable space and weight. This convenience makes it possible for readers to have their entire library at their fingertips, whether they are commuting, traveling, or simply enjoying a lazy afternoon at home. Additionally, digital files are easily searchable, enabling readers to locate specific information within seconds. With a few keystrokes, users can search for keywords, topics, or phrases, making research and finding relevant information a breeze. This efficiency saves time and effort, streamlining the learning process and allowing individuals to focus on extracting the information they need. Furthermore, the availability of free PDF books and manuals fosters a culture

of continuous learning. By removing financial barriers, more people can access educational resources and pursue lifelong learning, contributing to personal growth and professional development. This democratization of knowledge promotes intellectual curiosity and empowers individuals to become lifelong learners, promoting progress and innovation in various fields. It is worth noting that while accessing free Simon Eagle 3221e Technical Service Manual PDF books and manuals is convenient and cost-effective, it is vital to respect copyright laws and intellectual property rights. Platforms offering free downloads often operate within legal boundaries, ensuring that the materials they provide are either in the public domain or authorized for distribution. By adhering to copyright laws, users can enjoy the benefits of free access to knowledge while supporting the authors and publishers who make these resources available. In conclusion, the availability of Simon Eagle 3221e Technical Service Manual free PDF books and manuals for download has revolutionized the way we access and consume knowledge. With just a few clicks, individuals can explore a vast collection of resources across different disciplines, all free of charge. This accessibility empowers individuals to become lifelong learners, contributing to personal growth, professional development, and the advancement of society as a whole. So why not unlock a world of knowledge today? Start exploring the vast sea of free PDF books and manuals waiting to be discovered right at your fingertips.

FAQs About Simon Eagle 3221e Technical Service Manual Books

How do I know which eBook platform is the best for me? Finding the best eBook platform depends on your reading preferences and device compatibility. Research different platforms, read user reviews, and explore their features before making a choice. Are free eBooks of good quality? Yes, many reputable platforms offer high-quality free eBooks, including classics and public domain works. However, make sure to verify the source to ensure the eBook credibility. Can I read eBooks without an eReader? Absolutely! Most eBook platforms offer webbased readers or mobile apps that allow you to read eBooks on your computer, tablet, or smartphone. How do I avoid digital eye strain while reading eBooks? To prevent digital eye strain, take regular breaks, adjust the font size and background color, and ensure proper lighting while reading eBooks. What the advantage of interactive eBooks? Interactive eBooks incorporate multimedia elements, quizzes, and activities, enhancing the reader engagement and providing a more immersive learning experience. Simon Eagle 3221e Technical Service Manual is one of the best book in our library for free trial. We provide copy of Simon Eagle 3221e Technical Service Manual in digital format, so the resources that you find are reliable. There are also many Ebooks of related with Simon Eagle 3221e Technical Service Manual. Where to download Simon Eagle 3221e Technical Service Manual online for free? Are you looking for Simon Eagle 3221e Technical Service Manual PDF? This is definitely going to save you time and cash in something you should think about. If you trying to find then search around for online. Without a doubt there are numerous

these available and many of them have the freedom. However without doubt you receive whatever you purchase. An alternate way to get ideas is always to check another Simon Eagle 3221e Technical Service Manual. This method for see exactly what may be included and adopt these ideas to your book. This site will almost certainly help you save time and effort, money and stress. If you are looking for free books then you really should consider finding to assist you try this. Several of Simon Eagle 3221e Technical Service Manual are for sale to free while some are payable. If you arent sure if the books you would like to download works with for usage along with your computer, it is possible to download free trials. The free guides make it easy for someone to free access online library for download books to your device. You can get free download on free trial for lots of books categories. Our library is the biggest of these that have literally hundreds of thousands of different products categories represented. You will also see that there are specific sites catered to different product types or categories, brands or niches related with Simon Eagle 3221e Technical Service Manual. So depending on what exactly you are searching, you will be able to choose e books to suit your own need. Need to access completely for Campbell Biology Seventh Edition book? Access Ebook without any digging. And by having access to our ebook online or by storing it on your computer, you have convenient answers with Simon Eagle 3221e Technical Service Manual To get started finding Simon Eagle 3221e Technical Service Manual, you are right to find our website which has a comprehensive collection of books online. Our library is the biggest of these that have literally hundreds of thousands of different products represented. You will also see that there are specific sites catered to different categories or niches related with Simon Eagle 3221e Technical Service Manual So depending on what exactly you are searching, you will be able tochoose ebook to suit your own need. Thank you for reading Simon Eagle 3221e Technical Service Manual. Maybe you have knowledge that, people have search numerous times for their favorite readings like this Simon Eagle 3221e Technical Service Manual, but end up in harmful downloads. Rather than reading a good book with a cup of coffee in the afternoon, instead they juggled with some harmful bugs inside their laptop. Simon Eagle 3221e Technical Service Manual is available in our book collection an online access to it is set as public so you can download it instantly. Our digital library spans in multiple locations, allowing you to get the most less latency time to download any of our books like this one. Merely said, Simon Eagle 3221e Technical Service Manual is universally compatible with any devices to read.

Find Simon Eagle 3221e Technical Service Manual :

the book of meditation the complete guide to modern meditation

~~the berenstain bears moving day~~

the black angel a charlie parker thriller

the book against god a novel

the call of the master

the billionaires gentle rescue the sisterhood book english edition

the best recipe grilling and barbecue

the billionaires secretary billionaire alphas book english edition

the busy scrapper courtney walsh

the book of the lion

the billionaire s masquerade bdsm billionaire public sex exhibitionism erotica

the business career in its public relations

the billionaire s bet

the bimbo hit the bimbo hits book english edition

the brassworthy summer fayre english edition

Simon Eagle 3221e Technical Service Manual :

irc ccna curriculum certification info cisco press - Feb 01 2023

web ccna certification remains the premier starting point for a successful career in networking and it recently updated ccna now covers a broad range of fundamentals based on

ccna1 v7 0 introduction to networks itn sunrise institute - Apr 22 2022

web apr 9 2020 the command to apply an extended ipv4 acl to an interface is the same as the command used for standard ipv4 acls router config if ip access group access

ccna curriculum version 5 0 youtube - May 24 2022

web jan 23 2023 the ccna 7 0 curriculum provides an integrated and comprehensive coverage of networking topics including ip routing and switching fundamentals network

ccna 5 0 curriculum overview pdf uniport edu - Jul 26 2022

web ccna 5 0 curriculum overview 5 5 technology delivering labs based independent reviews of the latest products and services our expert industry analysis and practical

ccna certification guide cisco - Mar 02 2023

web the companion books to support the new ccna curriculum will publish shortly after the release of each course and wireless essentials v7 0 srwe companion guide

ccna exam topics cisco learning network - Jun 05 2023

web draft curriculum overview typepad

courseware ccna routing switching - Oct 09 2023

web the new ccna 5 0 curriculum will still continue to focus on routing and switching technologies which aligns with the content and ccna certifications the expected phase

cisco ccna kursu network eğitimi vektörel bilişim - Oct 29 2022

web ccna 5 0 curriculum over book review unveiling the magic of language in a digital era where connections and knowledge reign supreme the enchanting power of language

ccna 5 0 curriculum over assets ceu social - Sep 27 2022

web ccna 5 0 curriculum overview 1 ccna 5 0 curriculum overview resources in education cisco router firewall security all in one enterprise network core technologies

draft curriculum overview typepad - May 04 2023

web the cisco certified network associate v1 0 ccna 200 301 exam is a 120 minute exam associated with the ccna certification this exam tests a candidate s knowledge and

ccna 5 0 curriculum over pdf backoffice ceu social - Feb 18 2022

ccna 3 v7 0 curriculum module 5 acls for ipv4 configuration - Mar 22 2022

web ccna 5 0 curriculum over ccna 5 0 curriculum over 2 downloaded from backoffice ceu social on 2020 03 31 by guest to the course material the all new labs

cisco ccna essentials webinar series - Dec 31 2022

web may 25 2023 the updated ccna syllabus or curriculum for 2023 covers a range of topics that are essential for networking professionals the syllabus emphasises practical

ccna syllabus updated syllabus of ccna in 2023 the - Nov 29 2022

web ders peşin fiyatına 5 142 80 x 5 30 cisco ccna kursu ile alanında uzman cisco yetkili network eğitmenlerden uygulamalı güncel harika bir cisco ccna eğitimi alın

ccna 5 0 curriculum overview copy store spiralny - Jun 24 2022

web ccna curriculum version 5 0 link ccna v5 weebly com

new ccna 5 0 curriculum networkjutsu - Sep 08 2023

web ccna exam covers networking fundamentals ip services security fundamentals automation and programmability designed for agility and versatility ccna validates that

ccna 5 0 curriculum overview japanalert bananacoding - Aug 27 2022

web jun 27 2023 ccna 5 0 curriculum overview 1 9 downloaded from uniport edu ng on june 27 2023 by guest ccna 5 0

curriculum overview this is likewise one of the factors by
[ccna 5 0 curriculum overview pdf db csda](#) - Jul 06 2023

web 1 5 compare tcp to udp 1 6 configure and verify ipv4 addressing and subnetting 5 0 security fundamentals 15 5 1 define key security concepts threats vulnerabilities

[ccna training certifications cisco](#) - Aug 07 2023

web 4 ccna 5 0 curriculum overview 2022 02 06 routing and switching complete study guide 2nd edition coverage includes lan switching technologies ip routing ip

ccna cisco learning network - Apr 03 2023

web examined data from over 9 500 technology professionals those your ccna certification can make your resume stand out and gets your foot in the door the ccna arms you

earned value project management 4th edition vitalsource - Feb 27 2022

web earned value project management 4th edition author s quentin fleming joel koppelman publisher project management institute format reflowable what s this print isbn 9781935589082 1935589083 etext isbn 9781935589419 1935589415

edition 4th 12 25 usd 9781935589419r30 rent or buy etextbook 30 days

[earned value project management fourth edition hardcover](#) - Aug 04 2022

web management leadership buy new 80 67 was 94 49 save 13 82 14 select delivery location in stock us imports may differ from local products additional terms apply learn more quantity add to cart buy now payment secure transaction ships from amazon us sold by amazon us payment secure transaction

[earned value project management fourth edition](#) - May 13 2023

web sep 1 2010 earned value project management fourth edition fourth edition fourth edition by quentin w fleming phd msc author joel m koppelman author 4 2 out of 5 stars 99 ratings

earned value project management fourth edition rose 2011 - Oct 26 2021

web mar 1 2011 earned value project management fourth edition kenneth h rose pmp first published 01 march 2011 doi org 10 1002 pmj 20243 read the full text

project management using earned value fourth edition - Jan 29 2022

web project management using earned value fourth edition project management using earned value is the definitive resource for earned value project management and earned value management systems evms this book is about how the planning control and management of projects can be improved through the use of the concept called earned

earned value project management fourth edition - Feb 10 2023

web sep 1 2010 earned value project management fourth edition fourth edition fourth edition by quentin w fleming phd msc

author joel m koppelman author 3 9 5 ratings see all formats and editions kindle

earned value project management google books - Apr 12 2023

web an important addition to earned value project management fourth edition is the discussion of the two perceptions of the evm concept both are valid but one is better suited to the management

earned value project management fourth edition deepdyve - Jul 03 2022

web apr 1 2011 deepdyve earned value project management fourth edition rose kenneth h project management journal volume 42 3 apr 1 2011 1 page article details recommended references bookmark add to folder cite social times cited web of science journals project management journal volume 42 issue 3 subject

[earned value project management fourth edition apple books](#) - Dec 08 2022

web dec 1 2016 the third edition expanded the information available on of evpm for medium and smaller projects while still being relevant for larger projects an important addition to earned value project management fourth edition is the discussion of the two perceptions of the evm concept both are valid but one is better suited to the

earned value project management fourth edition scribd - Mar 11 2023

web dec 20 2016 an important addition to earned value project management fourth edition is the discussion of the two perceptions of the evm concept both are valid but one is better suited to the management of major projects while

earned value project management fourth edition skillsoft - Jun 14 2023

web earned value project management evpm is a methodology used to measure and communicate the real physical progress of a project taking into account the work completed the time taken and the costs incurred to complete that work

[earned value project management fourth edition researchgate](#) - Dec 28 2021

web apr 1 2011 download citation on apr 1 2011 kenneth h rose published earned value project management fourth edition find read and cite all the research you need on researchgate

earned value project management 4th edition pdf - Aug 16 2023

web mar 22 2021 earned value project management 4th edition free pdf download fleming quentin w 232 pages year 2010 read online pdf room

earned value project management fourth edition hardcover - Nov 07 2022

web 40 38 have one to sell on amazon see all 3 images follow the author quentin w fleming earned value project management fourth edition hardcover sept 1 2010 by quentin w fleming author joel m koppelman author 4 2 97 ratings

earned value project management fourth edition - Jan 09 2023

web synopsis about this edition earned value project management evpm is a methodology used to measure and communicate the real physical progress of a project taking into account the work completed the time taken and the costs incurred to

project management using earned value humphreys - Sep 05 2022

web project management using earned value fourth edition earned value management consulting training

earned value project management 4th edition pdf - May 01 2022

web this book seeks to describe a simple form of earned value for use in the management of all projects 4 the genesis and evolution of earned value earned value is a concept the concept that an estimated value can be placed on all work to be performed and once that work is accomplished that same value can be considered to be earned a

earned value project management fourth edition - Sep 17 2023

web dec 20 2016 earned value project management fourth edition quentin w fleming joel m koppelman project management institute dec 20 2016 business economics 231 pages

download earned value project management 4th edition pdf - Nov 26 2021

web download pdf earned value project management 4th edition pdf 2bdpkuf4eq4g this book is a methodology used to measure and communicate the real physical progress of a project taking into account t

book review earned value project management fourth edition - Oct 06 2022

web apr 1 2011 book review earned value project management fourth edition based on earned value project management fourth edition by fleming quentin w and koppelman joel m project management institute 2010 isbn 9781935589082 hardcover 231 pp 39 95 member 49 95 nonmember

earned value project management fourth edition chegg - Mar 31 2022

















web sep 1 2010 rent earned value project management fourth edition 4th edition 978 1935589082 today or search our site for other textbooks by quentin w fleming every textbook comes with a 21 day any reason guarantee published by



























































earned value project management fourth edition perlego - Jun 02 2022

web earned value project management fourth edition read this book now share book 231 pages english epub mobile friendly and pdf available on ios android ebook epub earned value project management fourth edition quentin w fleming joel m koppelman book details table of contents citations about this book

earned value project management fourth edition rose 2011 - Jul 15 2023

web mar 1 2011 earned value project management fourth edition kenneth h rose pmp reviewer director peninsula center for project management hampton va usa

75                 *ladki ka photo download* - Apr 12 2023

web dehati ladki ka photo                           dehati ladkiyon ki photo                                

                                - Oct 06 2022

web jun 23 2018 apni biwi ka doodh or chut ka pani pi sakta hnu reply pappu on november 6 2019 10 51 pm haan bhai piyo aur sabko pilao reply abhi thakur on june 13 2021 1 41 pm bhai mujhe bhi pina hai reply rahul on october 9 2019 2 53 pm ling ko kaise mumbai kre reply

chut image photos and premium high res pictures getty images - Jan 09 2023

web browse getty images premium collection of high quality authentic chut image stock photos royalty free images and pictures chut image stock photos are available in a variety of sizes and formats to fit your needs

ladka ladki photos poster images photos wallpapers hd images - Jul 03 2022

web 2 days ago ladka ladki photo gallery check out ladka ladki latest photos poster and images download free ladka ladki hd wallpapers hd images

laddii ko kaise chodte hain - Nov 07 2022

web vokal app bridges the knowledge gap in india in indian languages by getting the best minds to answer questions of the common man the vokal app is available in 11 indian languages users ask questions on 100s of topics related to love life career politics religion sports personal care etc we have 1000s of experts from different walks of

sexy desi ladki ki nangi photo boobs chut ki 52 xxx pics - Jan 29 2022

web april 18 2021 by goddess aphrodite desi girlfriends apne lover ka lund khada karne ke liye apni jawan nangi jism ka jalwa dikhati hain dekhiye unki gulabi chut juicy boobs is desi ladki ki nangi photo porn gallery mein aisi hot ladkiyon ko dekhne ke baad aapka mood mast ho jayega

free download borrow and - Aug 04 2022

web mar 5 2018 topics baap beti beti ki chudai beti ko choda incest virgin girl college girl

50 sexy desi girls chut pics hd jawan ladki ki bur photos - Feb 27 2022

web may 27 2021 in jawan ladkiyon ki nangi bur ko dekhkar aap chudai ke nashe mein doob jayenge ye latest hd desi girls chut pics aapke horny lund ko kamukta se bhar denge dekhiye in sexy girls ko jo apni tight pussy ki jhalak de rahi hain lund hilate hue in mazedar chut ke porn images ke maze lijiye

- Mar 31 2022

web jan 12 2018

ladki ki chudai ki photos xxx nangi chut ke photo images - Dec 28 2021

web ladki ki chudai ki photos xxx nangi images showing boobs pussy sexy girls ke chut ka photo dekh ke bhai kiska lund khada nahi hota he dekhe mast pyasi desi pussy hot indian vagina yani ki bur ke photos

[ladkiyo ki](#) - Jun 14 2023

web [anas](#) [sex](#)

nangi chut ki chudai xxx hd videos - Jul 15 2023

web soti hui ladki ki chut me ungli karke chudai kari with hot indian amateur anal indian desi aunty and desi bhabhi ki chut chudai indian desi bhabhi in desi chachi amma ne bete ka lund choos ke apni chut chudwa l amateur chubby milf chut hairy brunette hairy indian devar bhabhi and hot indian bhabhi ne apne devar ko chut

chut stock photos and images 123rf - Jun 02 2022

web your chut stock images are here download photos for free or search from millions of hd quality photos illustrations and vectors use them in your designs and social media posts thousands of new and contemporary pictures added daily

choti chut ki photo xxx hd videos - May 13 2023

web choti chut ki photo xxx sex videos bade bhai ne choti behen ke sath akele mein chudai ki fetish handjob teens hot indian biwi ki choti behan ke sth kari chudai brunette cunnilingus indian bade bhai aur choti behen ki gandhi baate and jabadast chudai fetish hairy webcam

[9](#) - Sep 05 2022

web the dancing women [vaginas](#)

1550 desi girls images pictures photos desicommments com - May 01 2022

web find desi girls pictures images comments for facebook whatsapp instagram and more you can download desi girls images and share them with your friends upload pictures

[16 saal ki ladki kamsin the untouched video dailymotion](#) - Feb 10 2023

web apr 22 2015 12 saal ki ladki bhaisa ka doodh doo rahi he animattings 0 25 12 saal ki ladki ne best naat sarif pada srfun 1 37 13 saal ki ladki ne ziadti karnay walay se kaisay badla liya awesome awesome 6 39 10 saal ki ladki bani maa viralvideonews 0 14 ha ha punjab di ladki ha ha punjab ki ladki song ha ha punjabi ladki ha ha

chuda chuda photos photos hd images pictures stills first - Mar 11 2023

web jan 22 2013 chuda chuda photo gallery check out chuda chuda movie latest images hd stills and download first look posters actor actress pictures shooting spot photos and more only on filmibeat photos

- Aug 16 2023

web nov 20 2019

- Dec 08 2022

web apr 15 2018

